

commercial systems

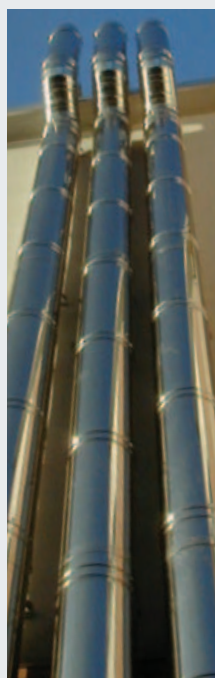

ventsflues&chimneys

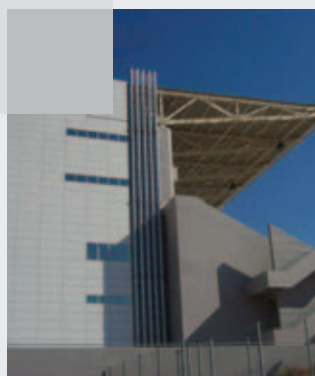
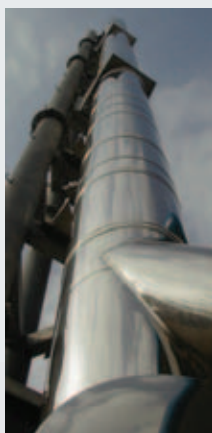

vents flues & chimneys

Schiedel Rite-Vent

Schiedel is the leading supplier of prefabricated chimney systems in Europe with the widest choice of chimney and flue products. Part of Lafarge, Schiedel is at the forefront in product and service innovation, with systems and solutions that are reliable, innovative and cost-effective.

Our products conform to the most stringent standards of design, manufacture and performance required world-wide, and are CE certified in accordance with EN1856 and manufactured under BS EN ISO 9001-2000 quality control systems.



The Complete Service

Whether it's a multi-flue chimney, a fan dilution system or a generator exhaust, we have a product to suit every commercial or industrial application. We also offer a full CAD design service and technical support. Both in the private and public-sector Schiedel Rite-Vent has unrivalled experience that you can rely on whatever the scale or nature of your project – from chimneys to exhaust and venting systems. On-site, our technical team can provide site analysis and application advice as required. We can design and manufacture for projects in the U.K. and Europe, and arrange for on-site installation from a small commercial installation to a large industrial application.



Services

- Site survey
- System selection for optimum cost and performance
- System sizing
- Termination siting advice to comply with the Clean Air Act
- Design and layout drawings
- On-site installation
- Ongoing technical support including facilities management and CCTV

Typical Applications

- Chimney Systems
 - Fluing systems
 - Natural draught
 - Fan assisted/ positive pressure
 - Fan dilution
 - Condensing
 - Modular header
 - CLV
- Exhaust systems
 - Generators, turbines, CHP
- Other Venting systems
 - Process plant
 - Bakery ovens
 - Smoke extraction
 - Passive ventilation
 - Fire rated service duct, cable duct
 - Rubbish chutes
- Support Systems
 - Building supported
 - Internal
 - External
 - Mast supported
 - Free-standing single/multi-leg
 - Windshield
 - Relining existing stack



The Clean Air Act

With government legislation aimed at improving the environment very carefull consideration must be given to the siting of any chimney termination. Understanding the demands and requirements of the Clean Air Act is paramount. When designing a flue or chimney system Schiedel Rite-Vent can advise on compliance with the Act's requirements and will give guidance on siting and discharge heights. As manufacturers, Schiedel Rite-Vent will produce all the calculations on behalf of the client ensuring performance and compliance.

W9

mast supported chimneys



BBC White City London

An example of how an architectural feature can be created by aesthetically enclosing an industrial flue system. At the BBC's flagship building in White City, London, seven individual flues were supported from a steelwork mast fixed at the top of the building. To comply with the Clean Air Act the chimney had to terminate 48 metres above ground level. The structure was clad with perforated aluminium sheeting creating a distinctive and attractive addition to the immediate skyline. The ICS system was used to service three heating boilers, one generator and three further flues for future appliances. By incorporating a platform and access ladder into the design future maintenance can be facilitated.

FLUE TERMINATION HEIGHT TO MEET CLEAN AIR ACT

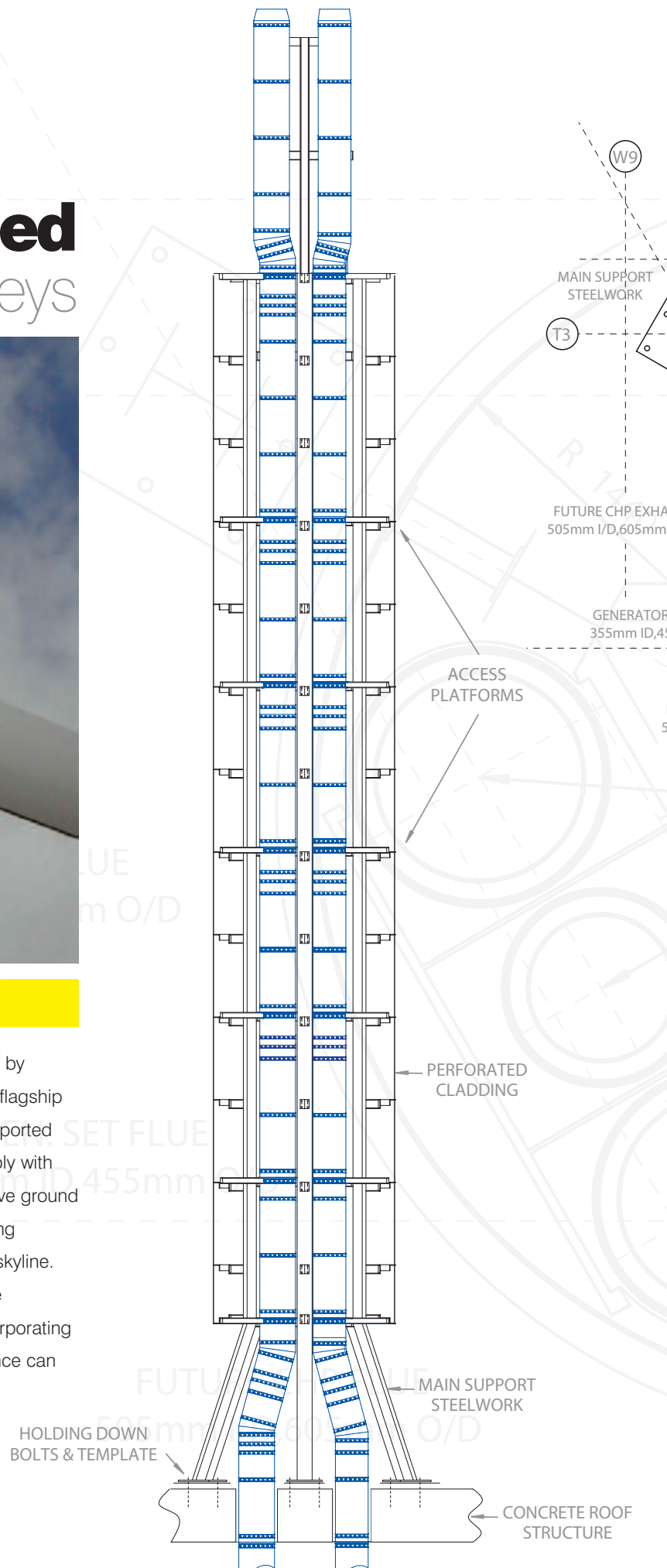

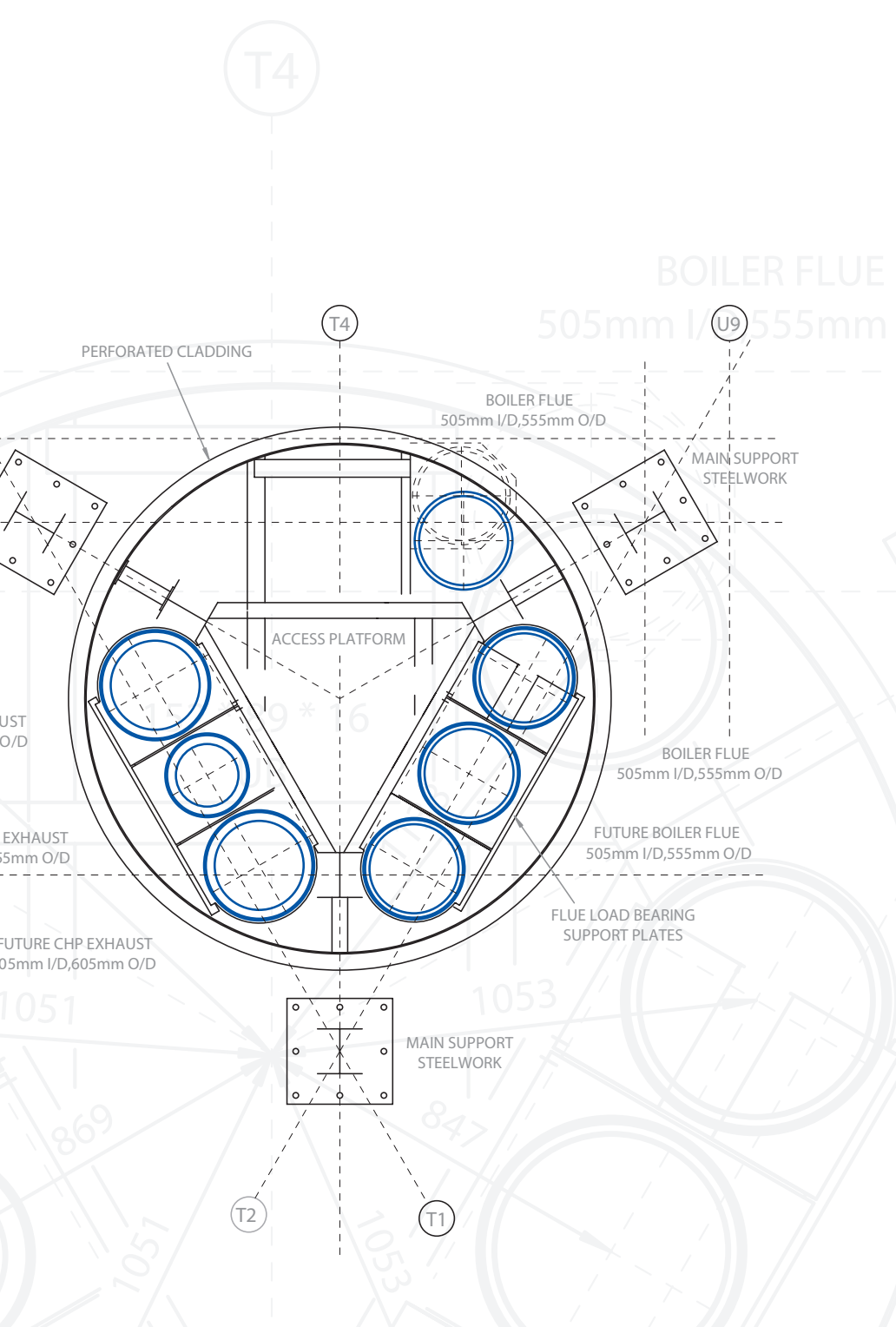

Product Specification

Heating Boilers : **ICS 25**

CHP Exhaust : **ICS 5000**

Generator Exhaust : **ICS 5000**



“ Enclosed within an attractive architectural structure mast supported chimneys can accommodate a number of lightweight flues within a variety of shaped frames ”

mast supported chimneys



The Royal Bank of Scotland, Edinburgh

Aesthetics were an important element of the chimney design at the Royal Bank of Scotland's new world headquarters on the outskirts of Edinburgh. Working with the main contractor and Crown House Technologies, Schiedel Rite-Vent determined the height for the chimney terminations at a height of 8 metres above roof level to comply with the Clean Air Act. The eight flues serving two pressure jet boilers, two condensing boilers and four diesel generators were then enclosed by an architect designed windshield, adding a striking feel to the design of the building. As no support was available at ground level the load had to be spread between first-floor slab and the roof. Schiedel Rite-Vent produced the design calculations to take into account the support weight, flue weight and wind load/stress.

Flues for a further six plant rooms at this site have been manufactured by Schiedel Rite-Vent.

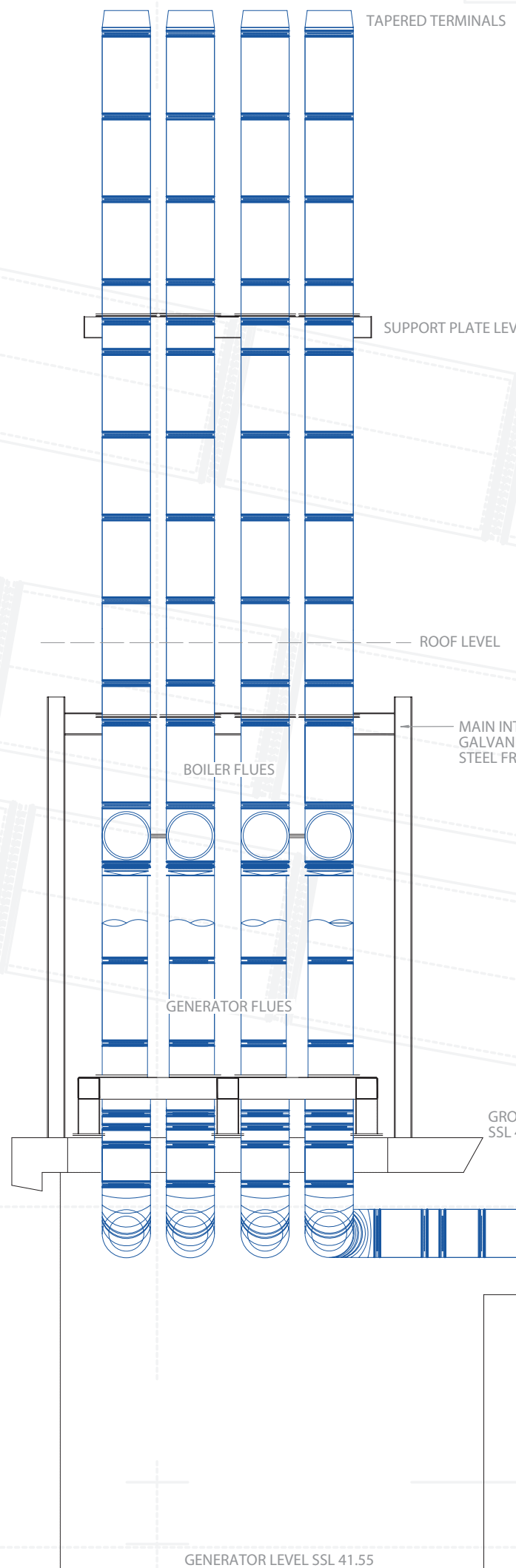

Product Specification

Condensing Boilers : **ICS Plus**

Heating Boilers : **ICS 25**

Generator Exhaust : **ICS 5000**

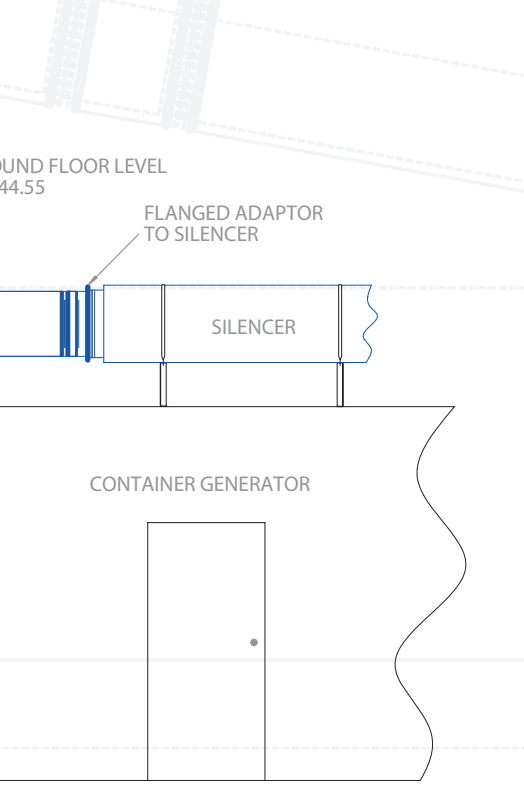
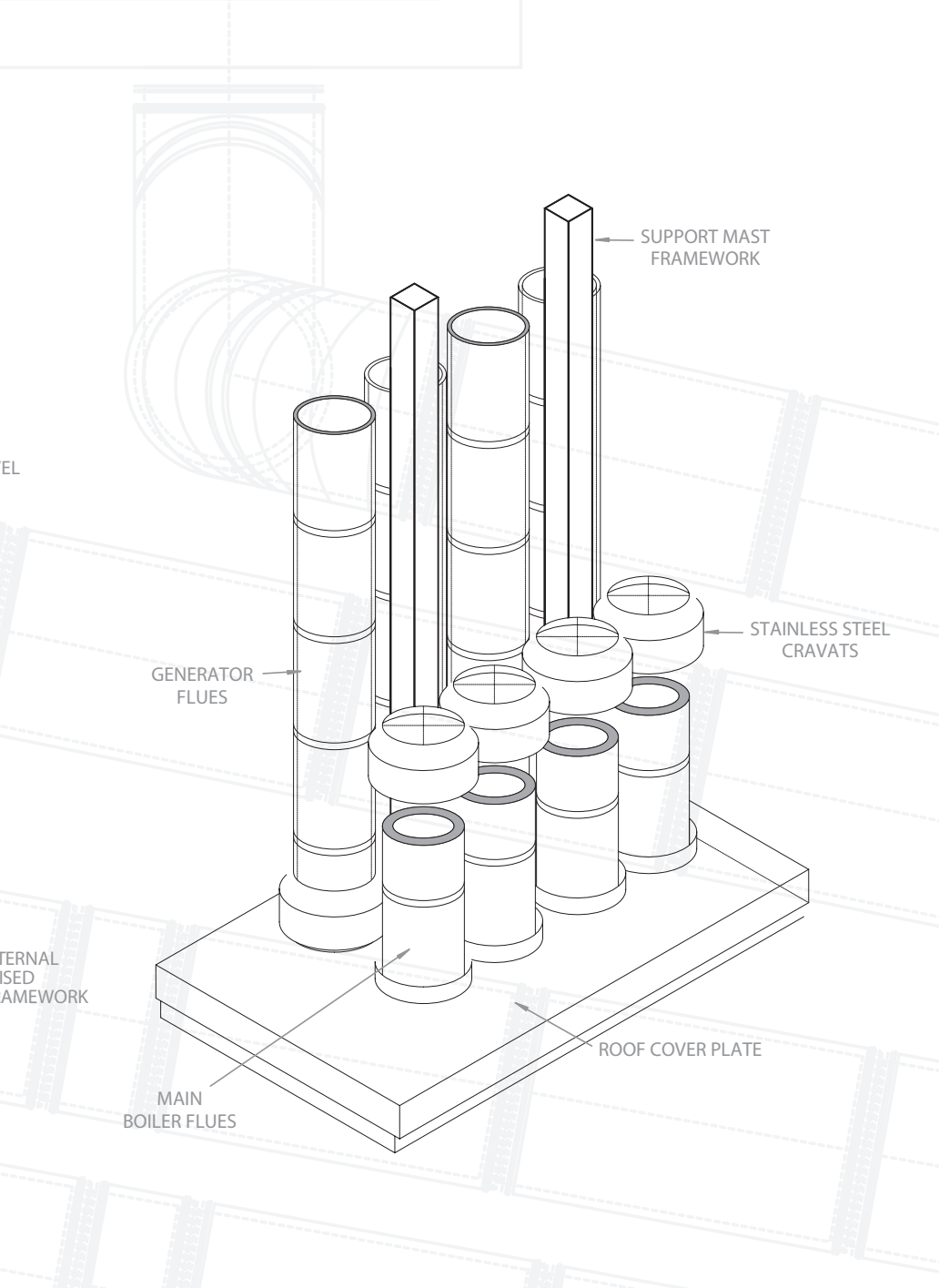

“ The advantage of a mast supported chimney is that it is light in weight and can be easily lifted into position ”

building supported chimneys

EXTENDED LOCK
ALLOWING FLUE TO RISE
UP TO 4 METRES (UNSTAYED)



Glasgow PFI Schools

Proving its flexibility in handling a multi-site contract, Balfour Kilpatrick working for North Lanarkshire Council have awarded a multi schools PFI contract to Schiedel Rite-Vent. Following the completion of an initial contract for six schools as programmed, the contractor awarded the next stage of the project to Schiedel. Each system was individually designed and then manufactured and installed to ensure that both the boiler manufacturer's draught requirements and all the current environmental standards were fully complied with. Being lightweight and space-saving these systems are quick and easy to erect. They can be concealed internally or used as a feature externally and are easy to inspect and maintain.



Product Specification

Condensing Boilers : **ICS Plus**

ING BANDS
(FREESTAND
SUPPORTED)

FORM COLLAR
BUILDERS
UPSTAND

BASE TEE &
SUPPORT



“ As building supported chimneys are prefabricated they can be installed internally or externally and are easier and quicker to erect ”

free standing chimneys



Queens Park Hospital, Blackburn

This installation, designed for a minimum operational life of thirty years, consisted of four flues to service two existing and two new boilers in the plant room. To comply with the Clean Air Act, a 25.2 metre high free-standing chimney was constructed, containing its own internal lighting system and an aircraft warning light. The specially designed concrete base includes cast-in bolts calculated by Schiedel Rite-Vent to allow for weight and wind load.

The windshield and support arrived on site in two sections which were assembled in one day. To enable the hospital's continuous operation the flues were installed in four phases to assist boiler changeover.

Free-standing structures require smaller foundations as they are more stable than using a single support or framed mast. Erection time is reduced and external scaffolding is not required.

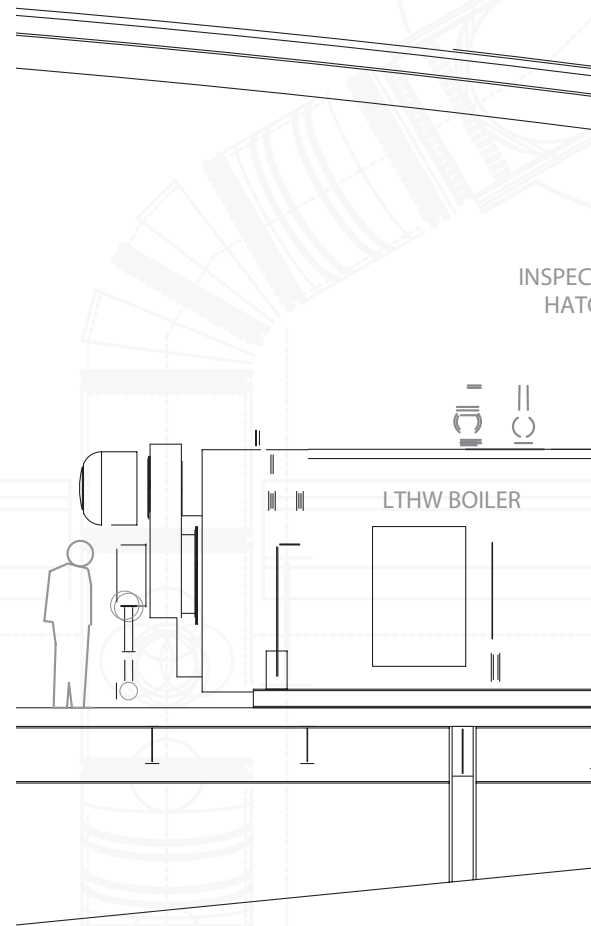

FLUES SUPPORTED FROM GROUND
ON PURPOSE MADE STANDS

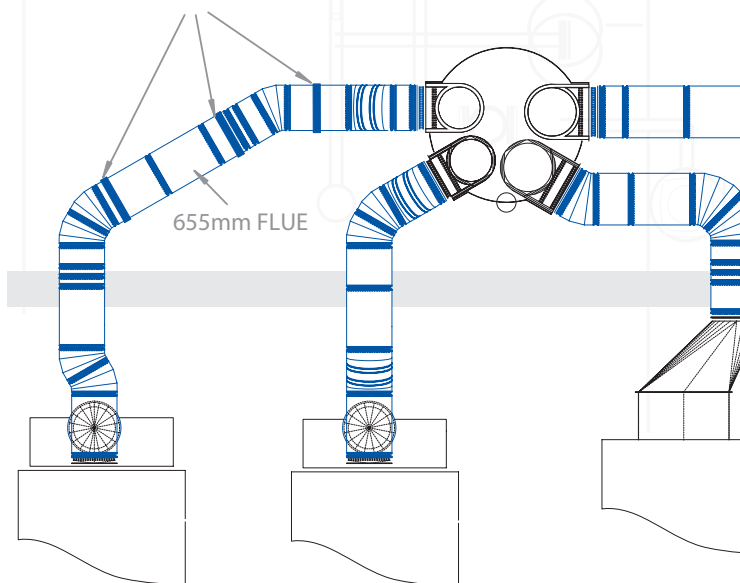

Product Specification

Heating Boilers : **ICS 25**

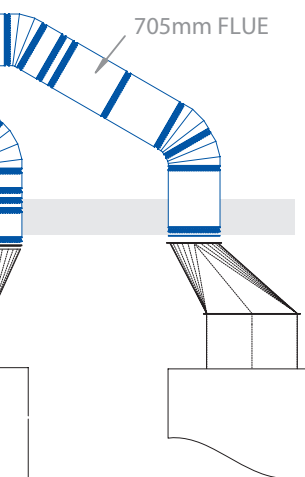
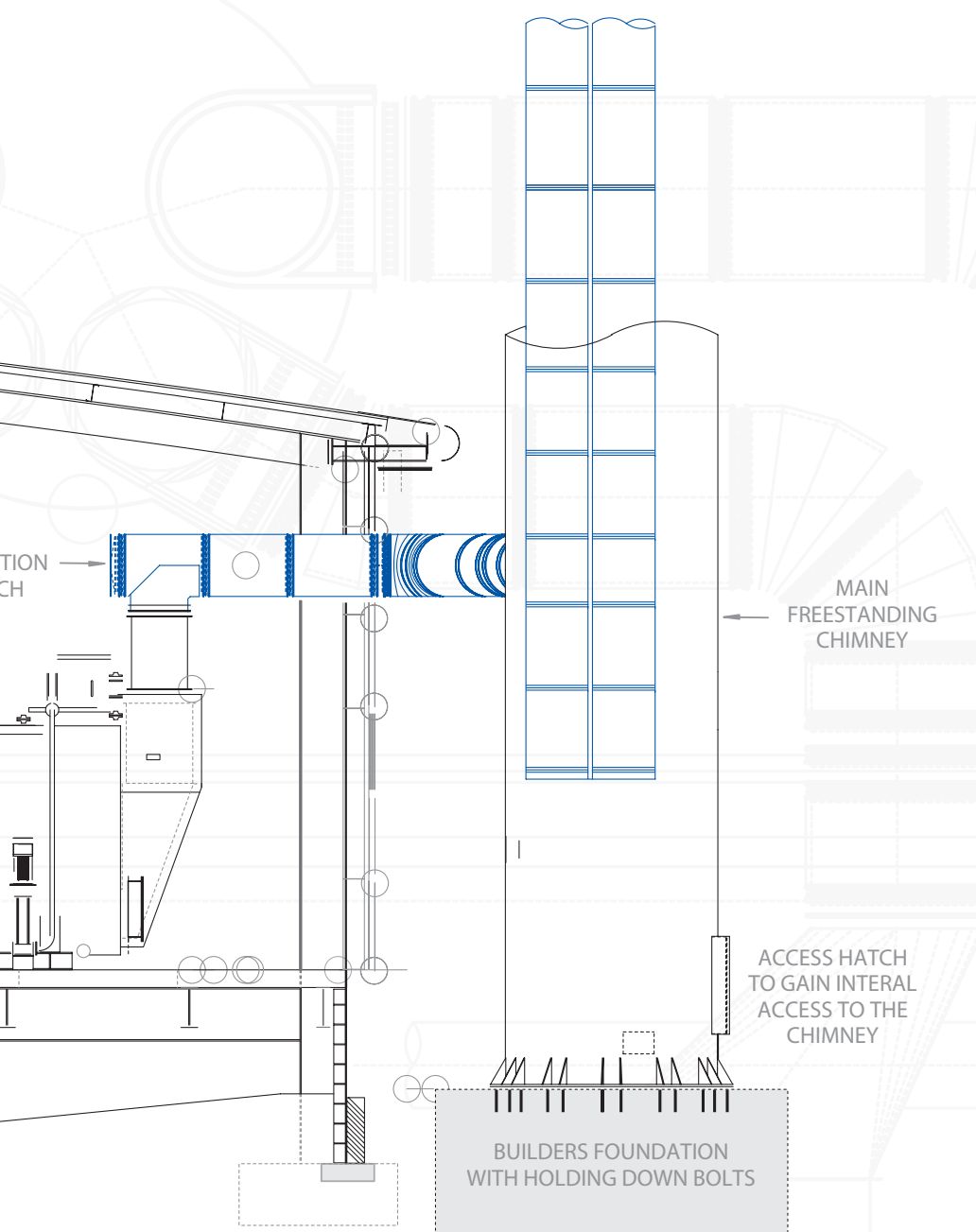

“ Normally constructed as a windshield, free-standing chimneys reduce on-site erection time ”

fan assisted chimneys



Moatside Court, Durham University

Fan assisted systems are designed to allow the use of a smaller sized flue where space is tight or where there are restrictions within a chimney. At Durham University Schiedel Rite-Vent designed a flue system which overcame complications caused by the restricted size of the existing brick chimney. Sited within one of the campus buildings the fan-assisted system controls the operating pressure and allows the use of a flue system with a reduced diameter.

Alternatively fan dilution systems are used to exhaust combustion products when an existing route is unusable, or if the cost of relining a chimney or installing a new flue is prohibitive. If for aesthetic reasons an external chimney is inappropriate to the building, a fan dilution system can be used to discharge the flue products at a low level of discharge.

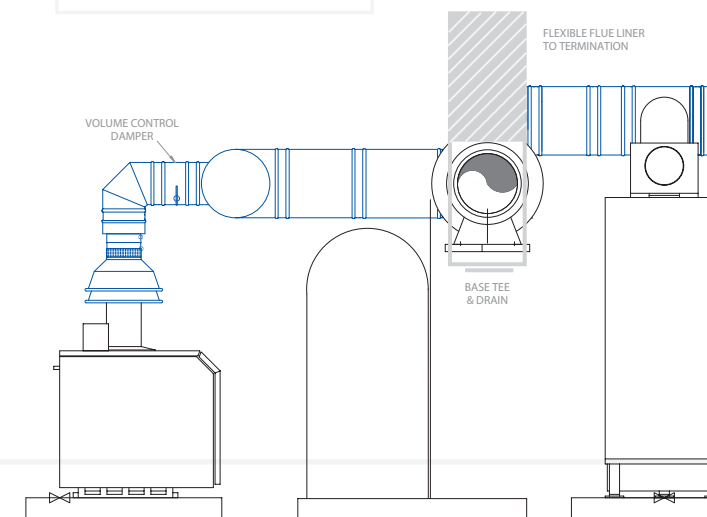
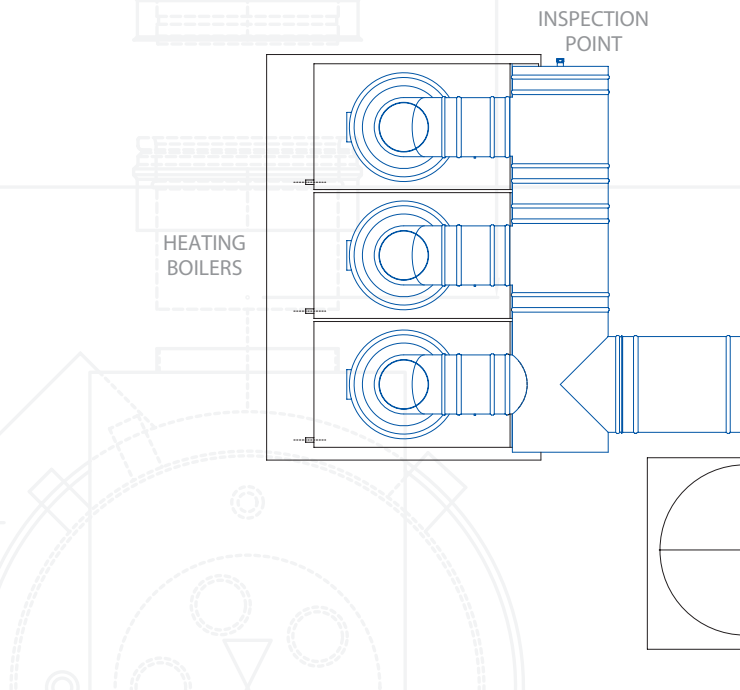

Product Specification

Heating Boilers : **ICS 25**

Water Heaters : **ICS 25**

Chimney Liner : **Turboflex Plus**

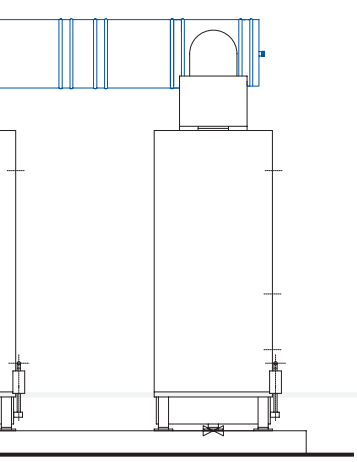
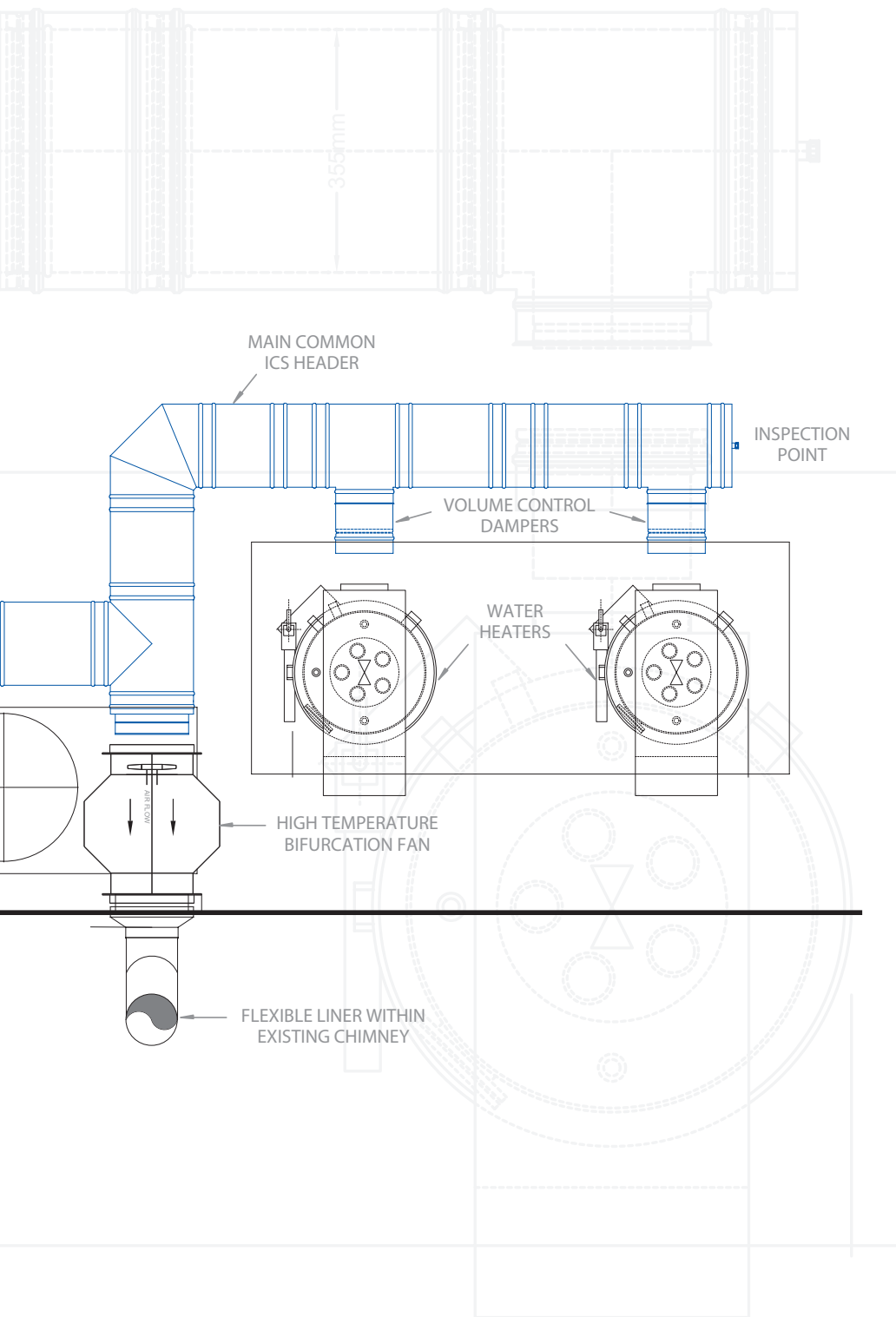

“Where size and space is restricted, fan assisted chimneys allow the use of a flue system with a reduced diameter”

ICS

A twin wall insulated chimney system for use on multi-fuel appliances.

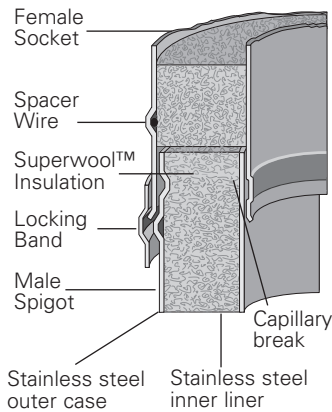

- Sleeve joint with locking band for:-
Lateral strength
Insulation continuity
Easy condensate draindown

- Capillary break prevents moisture egress

- Inner liner free to expand, even withstanding chimney fire

- Corrosion resistant design and construction

- The only stainless steel system to have passed the Gastec corrosion test

Fuel: Gas, oil, wood, coal

Firing temp: 450°C

Short firing temp: 550°C

Thermal shock: 1000°C

Mode of operation: Zero and negative pressure

Pressure capabilities: 40Pa

Diameter range: 80-755mm

Approvals: CE certified to EN1856-1. Kitemarked to BS 4543. 4 Hour fire rating to BS476 Pt 20. Manufactured to BS EN ISO 9001-2000.

ICS Plus

A twin wall insulated chimney system designed for condensing gas and oil appliances.

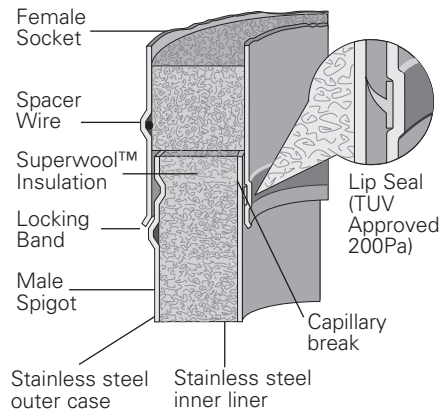

- Sleeve joint with locking band for:-
Lateral strength
Insulation continuity
Easy condensate draindown

- Capillary break prevents moisture egress

- Inner liner free to expand, even withstanding chimney fire

- Corrosion resistant design and construction

- The only stainless steel system to have passed the Gastec corrosion test

Fuel: Gas, oil

Firing temp: 160°C

Short firing temp: 200°C

Mode of operation: Positive pressure

Pressure capabilities: 200Pa

Diameter range: 80-755mm

Approvals: CE certified to EN1856-1. Kitemarked to BS 4543. 4 Hour fire rating to BS476 Pt 20. Manufactured to BS EN ISO 9001-2000.

ICS5000

A multi-functional twin wall insulated venting system for use on a wide range of heating appliances, stand-by power engines, CHP and service ducting.

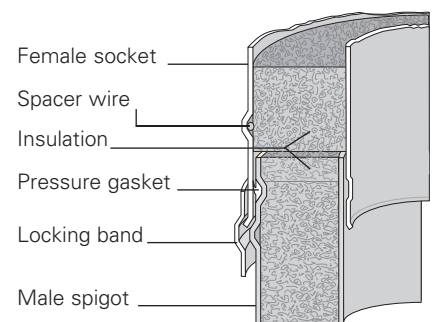

- Sleeve joint with pressure-retaining locking band for:-
Quick and sure assembly
Lateral strength
Assured insulation continuity
Easy condensate draindown

- Pressure seal on outer case
Protected by insulation for longest life

- Additional gasket can be fitted under locking band increasing joint security in arduous operating conditions and raising pressure capability towards 7500Pa

- Inner liner free to expand
No need for expansion joints

Fuel: Diesel, gas, oil, process wastes

Firing temp: 540°C

Short firing temp: 760°C

Thermal shock: 1000°C

Mode of operation: Positive, Zero and negative pressure

Pressure capabilities: 5000Pa

Diameter range: 150-605mm

Approvals: DIN 24194-1. DIN V244194-2. 4 Hour fire rating to BS476 Pt 20. Manufactured to BS EN ISO 9001-2000.

Prima Plus non-condensing

High performance multipurpose single wall for multi-fuel applications and chimney linings.

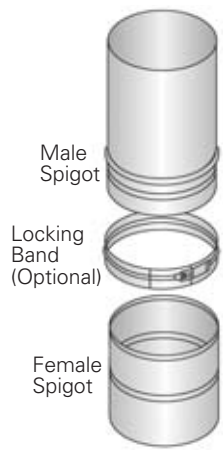

- Sleeve joint with optional locking band for:-
Lateral strength
Easy condensate draindown
- Capillary break prevents moisture egress
- Corrosion resistant design and construction
- Adjustable elbows and headers enable quick and precise alignment of flue runs
- 0.6 and 1.0mm thickness options to suit application

Fuel: Gas, oil, wood, coal
Firing temp: 450°C
Short firing temp: 600°C
Thermal shock: 1000°C
Mode of operation: Zero and negative pressure
Pressure capabilities: 40Pa
Diameter range: 80-755mm
Approvals: CE certified to EN1856-2, Kitemarked to Corrosion tested by GASTEC, MPA and TUV Manufactured to BS EN ISO 9001-2000.

Prima Plus condensing

High performance multipurpose single wall for atmospheric, and condensing applications and chimney linings.

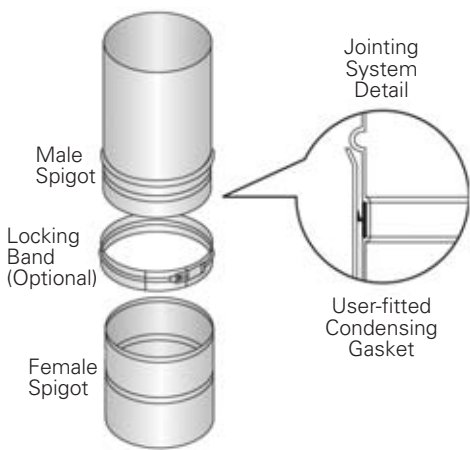

- Sleeve joint with optional locking band for:-
Lateral strength
Easy condensate draindown
- Capillary break prevents moisture egress
- Lip seal for condensing applications maintains positive pressure up to 200Pa
- Adjustable elbows and headers enable quick and precise alignment of flue runs
- 0.6 and 1.0mm thickness options to suit application

Fuel: Gas, oil
Firing temp: 160°C
Short firing temp: 200°C
Mode of operation: Positive pressure
Pressure capabilities: 1000Pa
Diameter range: 80-755mm
Approvals: CE certified to EN1856-2, Kitemarked to Corrosion tested by GASTEC, MPA and TUV Manufactured to BS EN ISO 9001-2000.

Tecno Flex (Turboflex Plus)

Stainless steel flexible flue for relining existing chimneys and suitable for use with multi-fuel appliances, including condensing systems.

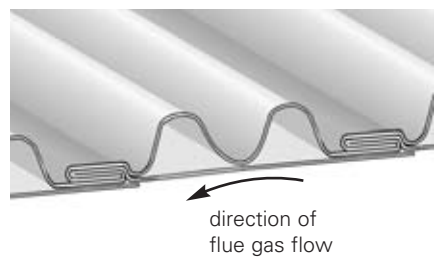

- Corrugated outer surface for high crush resistance
- Smooth inner surface resists corrosive attack due to easy drain down of condensate, less opportunity for soot collection and smooth surface for ease of sweeping
- The inner remains overlapping to protect the joint from corrosion penetration even at minimum bending radius
- The inner remains smooth and protective even after the rigours of installation

Fuel: Gas, oil, wood, coal
Firing temp: 450°C
Short firing temp: 600°C
Mode of operation: Zero and negative and positive pressure
Pressure capabilities: 200Pa
Diameter range: 80-400mm
Approvals: CE certified to EN1856-2, TUV Manufactured to BS EN ISO 9001-2000.

recent projects

- **Royal Bank of Scotland**
New World HQ, Gogarburn
- **Exhibition Centre, Brussels**
New commercial boilers
- **BBC Headquarters**
New Office Buildings, White City
- **Queens Park Hospital Blackburn**
PFI Hospital
- **Durham University**
New Student Accommodation
- **Olympic Stadium Athens**
(the main arena, tennis arena and 2 riding arenas)
- **Sanofi Chemicals**
Extension to Process Plant, Fawdon
- **Marks & Spencer**
Refurbishment of Stores, London, Bristol, Newcastle
- **Scottish Parliament**
Installation of Generator Exhaust
- **Radisson Edwardian**
Fire Gas Flue System
- **BAE Systems**
Installation of Mast and Boiler Flues
- **British Library**
New Flues to Boiler Plant
- **St Andrews University**
Installation of Various Systems within Campus
- **Stadio Olympic, Rome**
(Roma Soccer Stadium)
- **HMS Nelson Portsmouth**
Refurbishment of Naval Base
- **ASDA Superstore**
Installations at Various UK Stores
- **Mersey Tunnel**
Exhaust System for Generators, Liverpool
- **RAF Lossiemouth**
Work at RAF Base Heating Plant
- **Scottish Widows**
Office Redevelopment
- **Taikoo Project, Hong Kong**
(Diesel generators for Internet/telecommunications)
- **HM Prisons**
Various installations at Durham, Portsmouth, Perth
- **Langhans Restaurant London**
Flues to New Boilers
- **TIM, Italy**
(Telecommunications Buildings)
- **North Lanarkshire Schools**
PFI Schools, Scotland
- **Strathclyde University**
Work on University Buildings
- **UCL Hospitals**
New PFI Hospital, London
- **Maximum Security Prison, Sicily**
New commercial boilers



Schiedel Rite-Vent

Crowthor Estate
Washington
Tyne & Wear NE38 0AQ
Tel. +44 (0)191 416 1150
Fax. +44 (0)191 415 1263
sales@schiedelrite-vent.co.uk
www.schiedelrite-vent.co.uk

Schiedel Chimney Systems

Carrickmacross
Co. Monaghan
Ireland
Tel. +00353 (0)42 9661256
Fax. +00353 (0)42 9662494
office@schiedel.ie
www.schiedel.ie